

## Description

LP A2 series pressure switch opens or closes its electrical circuit depending on pressure rises or drops. Working pressure can be set from 7 bar to 600 bar by hand wheel on pressure switch. It has been designed suitable for using under high and shock pressures. It makes itself interesting for costumers thanks to easy adjustability and sensitivity. It has horizontal fitting connection holes for side flange connection. It has mountable design for all axis.

- LP A2 series pressure switch can be set thanks to hand wheel on pressure switch
- Desired pressure can be set easily thanks to pressure set scale.
- It has Aluminium body material
- NBR and Teflon seal equipments.

## Applications

- Hydraulic and mobile hydraulics
- Pneumatics
- Heavy-Duty machines industry
- Media; Compressed air, liquids, gases.

## Technical Features

Connection Type	: Side Flange Connection
Reproducibility	: Within %1 of set pressure
Working Temperature	: -20°C...+110°C
Vibration Test ( DIN EN 60068-2-6:1996 )	: 20 g ( Test Time 30 min. )
Shock Test ( DIN EN 60068-2-27:1993 )	: 30 g
Working Cycle	: 5 000 000 cycle
Viscosity Range	: Between 10 ... 800 mm <sup>2</sup> /sn
Electrical Features	: 5A 250VAC

### Notes

These values are maximum values and they can not be used at the same time. When you need to use the pressure switch in aggressive chemicals or fluids please contact with us. You must stict to rules of clearance standarts Hydraulic oils (fluids). Use filtration to blocking system errors. It is effective for long working life of pressure switches. Please avoid using out of indicated values to have a long service from pressure switch.



Order Codes

PRODUCT	PRODUCT CODE	PRESSURE RANGE	MAXIMUM SYSTEM PRESSURE (P <sub>MAX</sub> )	ELECTRICAL CONNECTION TYPE	CONNECTION TYPE
LP A2	LP A2 070	7 ... 70 bar	650 bar	NA / NC	SIDE FLANGE CONNECTION
	LP A2 160	10 ... 160 bar	650 bar		
	LP A2 300	20 ... 300 bar	650 bar		
	LP A2 400	20 ... 400 bar	650 bar		
	LP A2 600	50 ... 600 bar	750 bar		

Electrical Connection

Contact Connection Scheme

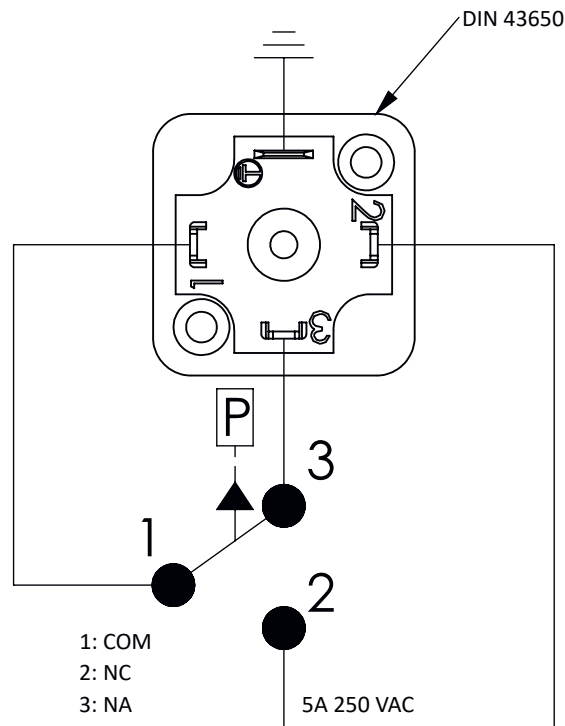

Switch Function

- Terminal 1 - 3 :It has current in case of pressure increasing. ( NA )
- Terminal 1 - 2 :It has current in case of pressure decreasing or no pressure. ( NC )

Pressure Differential Difference Graphics

Pressure Set Range  
7 ... 70 bar  
max set pressure 70 bar max system pressure 650 bar

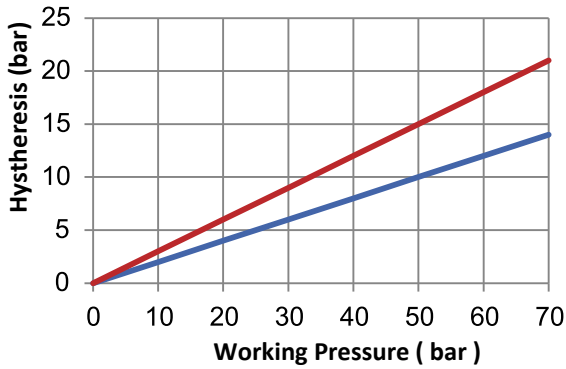

Pressure Set Range  
10 ... 160 bar  
max set pressure 160 bar max system pressure 650 bar

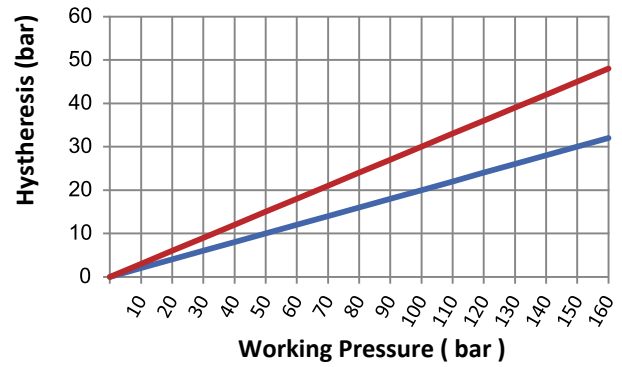

Pressure Set Range  
20 ... 300 bar  
max set pressure 300 bar max system pressure 650 bar

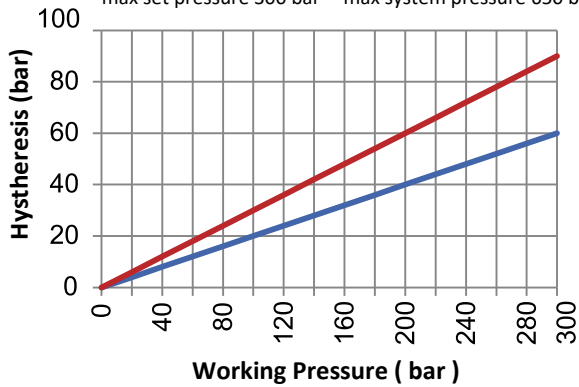

Pressure Set Range  
20 ... 400 bar  
max set pressure 400 bar max system pressure 650 bar

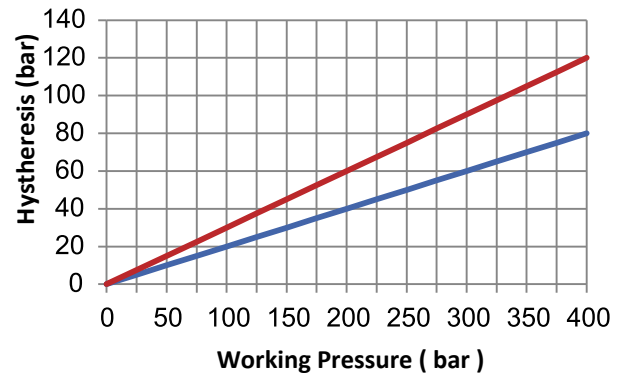

Pressure Set Range  
50 ... 600 bar  
max set pressure 600 bar max system pressure 650 bar

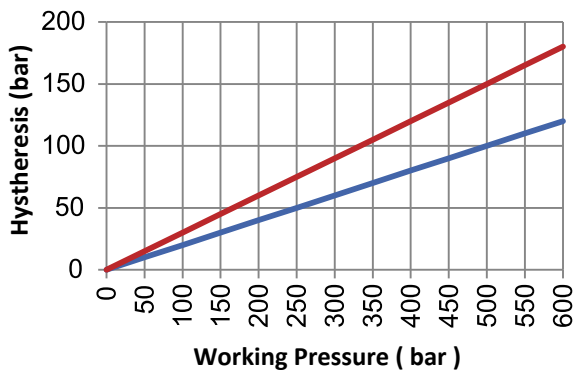

## Technical Dimensions

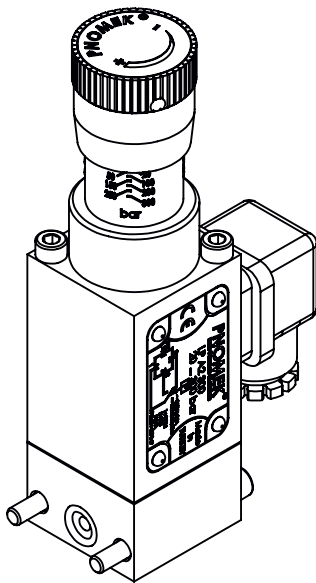
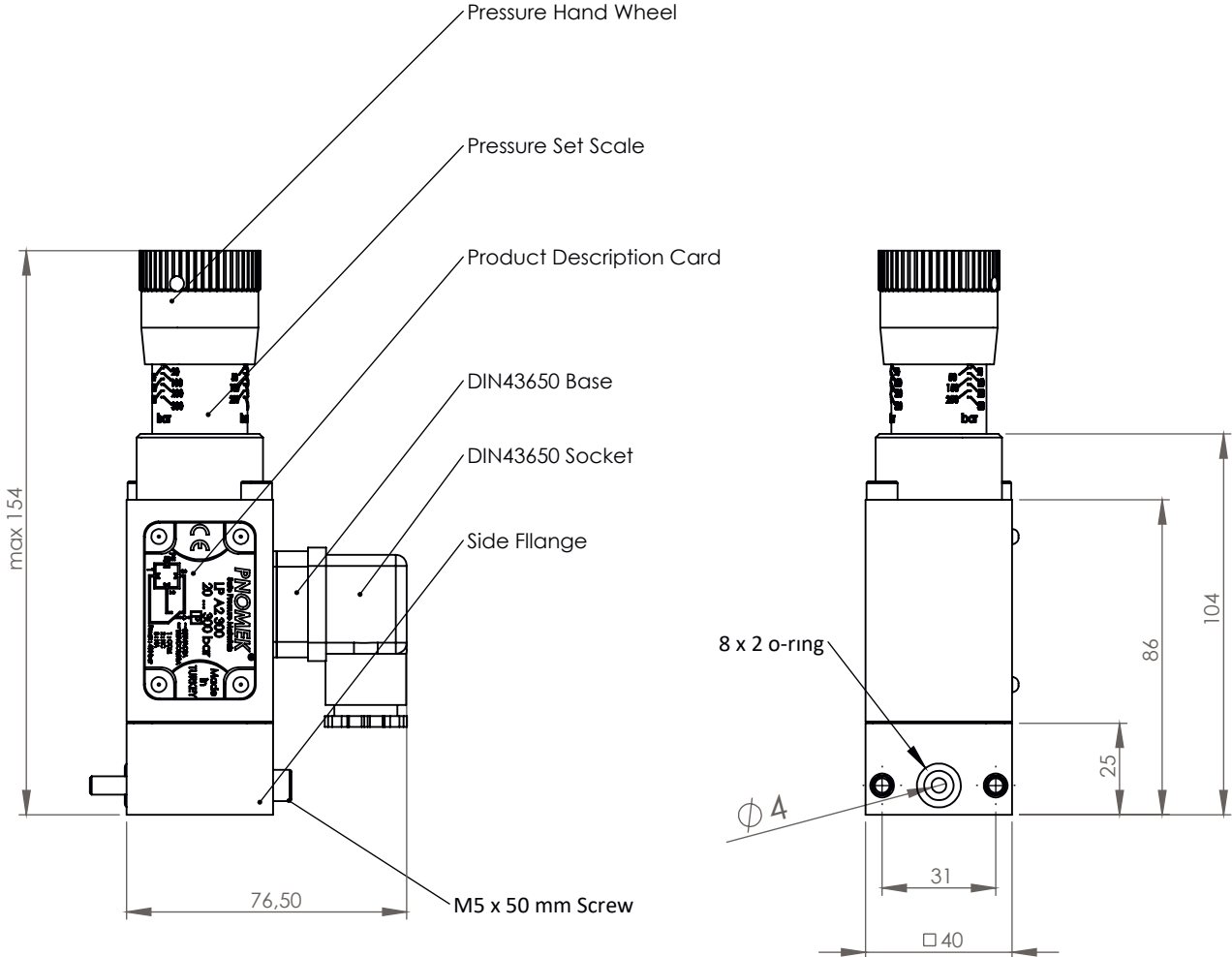

Not : 2 pieces M5 X 50 screws has been added with LP A2 series side flange connection pressure switch.

# PNOMEK

Safe pressure materials..

PNOMEK Hid. Pno. Mak. Kont. Cihazları San. Tic. Ltd. Ş  
Çalı Sanayi Bölgesi, Kırmızı Cd. No:16 Nilüfer-BURSA / TÜRKİYE  
pnomek@pnomek.com.tr  
T.: +90 (224) 251 63 45  
F.: +90 (224) 251 63 46